

Kingpin Monitor 1.0 TWIN 1 Sensor Installation Manual



Doc. Nr.: 20211102002
Version: 1.1

Status: APPROVED
Classification: PUBLIC
© 2021



Table of contents

- 1 Change history2
- 2 Warnings3
 - 2.1 Disclaimer3
 - 2.2 Adhesive.....3
- 3 3 Before assembly3
 - 3.1 Content of the Kingpin mounting kit for the sensor version: TWIN-I...3
 - 3.2 Required tools.....3
 - 3.3 View after assembly..... 4
- 4 Assembly steps 5
 - 4.1 Preparation.....5
 - 4.2 Loosening the screws and degreasing the adhesive surfaces.....6
 - 4.3 Fix QR Code Sticker with integrated NFC Tag on Hitch7
 - 4.4 Activation of the sensor 8
 - 4.5 Adhesive sensor housing to the pin9
 - 4.6 Screw the sensor housing to the pin.....9
 - 4.7 Mounting of the magnet..... 11
 - 4.8 Checking the locking sensor..... 13
 - 4.9 Mount the external Kingpin sensor in the funnel 13
 - 4.10 Checking the distance from the Kingpin sensor to the funnel14
- 5 Functional test of the complete system 15
- 6 Display Installation & Pairing of Kingpin Kit with Globehopper 17

1 Change history

Version	Author	Publication	Reason for change
1.1	Nexxiot AG	2021-11-10	QR/NFC Update
1.0	Nexxiot AG	2021-11-02	Translation of German original



2 Warnings

2.1 Disclaimer

The Kingpin Monitor 1.0 system does not replace the manual checking of the hitch condition during loading or unloading by the wagon master! It is only to be understood as a support of this process! Nexxiot AG assumes no liability for damages including consequential damages of any kind caused by faulty assembly of the sensors or displays!

2.2 Adhesive

The processing times specified in this document are based on the manufacturer's data sheet and may vary depending on the ambient temperature! Specifically: All data are based on a laboratory temperature of 24°C, at a higher ambient temperature the curing reaction is accelerated and thus shortens the open processing time. At a lower ambient temperature, the curing reaction is slowed down and thus prolongs the open processing time.

If gluing is required at very high or very low temperatures, please contact the manufacturer for further assistance! (EBS GmbH)

3 3 Before assembly

3.1 Content of the Kingpin mounting kit for the sensor version: TWIN-I

1. 1x Kingpin sensor housing with inscription Type: TWIN-I
2. 2x Kingpin Display
3. 1x magnet in magnetic holder (20x10x1)

3.2 Required tools

- 2x M10 - Key
- Flex / Sheet metal cutter for sheet metal cutting
- Aid for degreasing: detergents, spatulas, cleaning cloth
- Kingpin test adapter to test correct functionality
- Test display or display made of kit



3.3 View after assembly

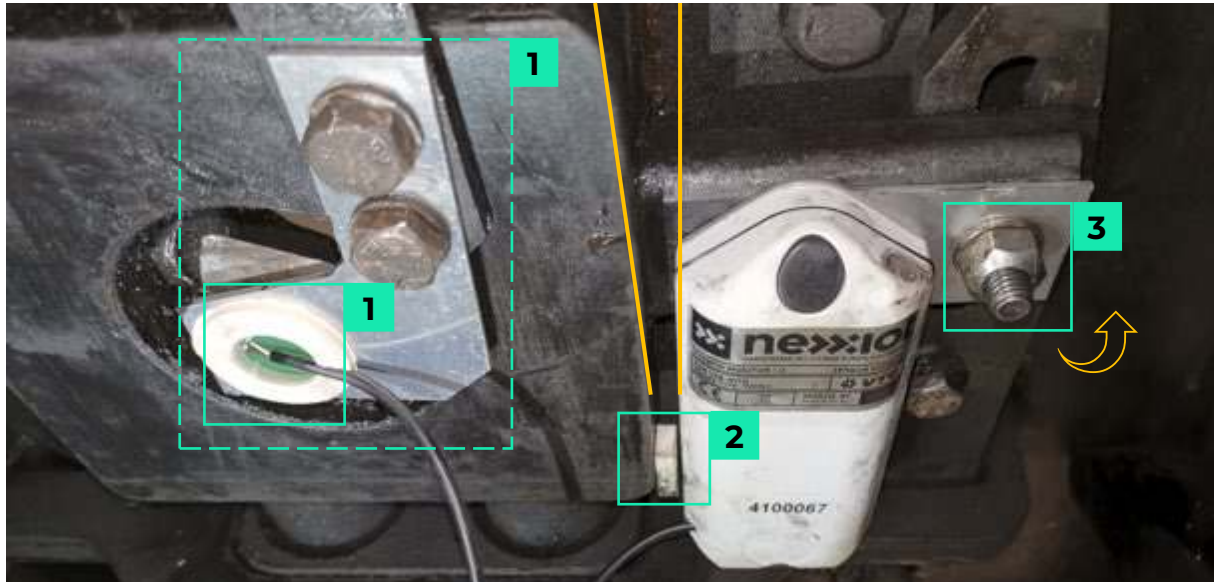

1. External Kingpin Sensor & L-Metal Mount

2. Locking magnet and magnetic switch in the housing

3. Metal bracket housing (glued and screwed to locking latch)

Pay attention to a possible twist when screwing on, correct alignment if necessary!

Attention: When bonding the housing plate, pay attention to parallel alignment! Long housing side must be parallel to the yellow lines of the middle block.

When locked, the distance from the magnetic housing to the sensor housing must not exceed 1mm! However, contact of the housing with the locking magnet must also be prevented



4 Assembly steps

Important: Please follow all steps in the instructions in the exact order and don't skip any step!

4.1 Preparation

Raise the support frame to the highest position!

As can be seen in the photo below, remove the lower mudguard on the right side, cut it off and screw it back on.

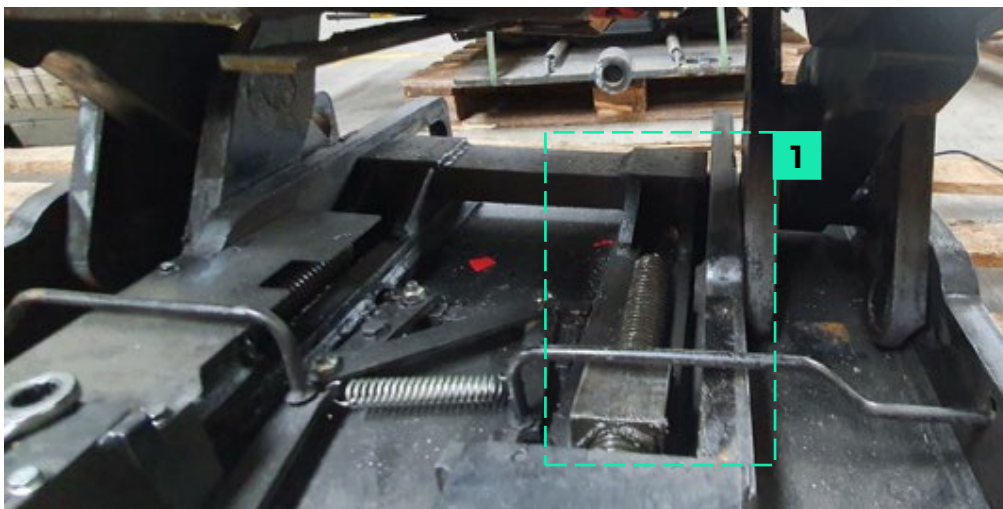

1. View with mudguard removed

Remove 3x mudguard screws and cut off the cover (with f.ex. a Flex), then screw on it again

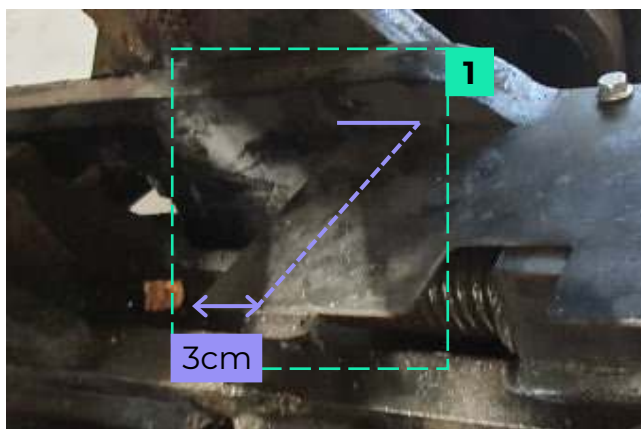

1. Cutting edges

Reason for cutting: The removed part of the mudguard would otherwise collide with the sensor housing when driving together to the last centimeter.



4.2 Loosening the screws and degreasing the adhesive surfaces

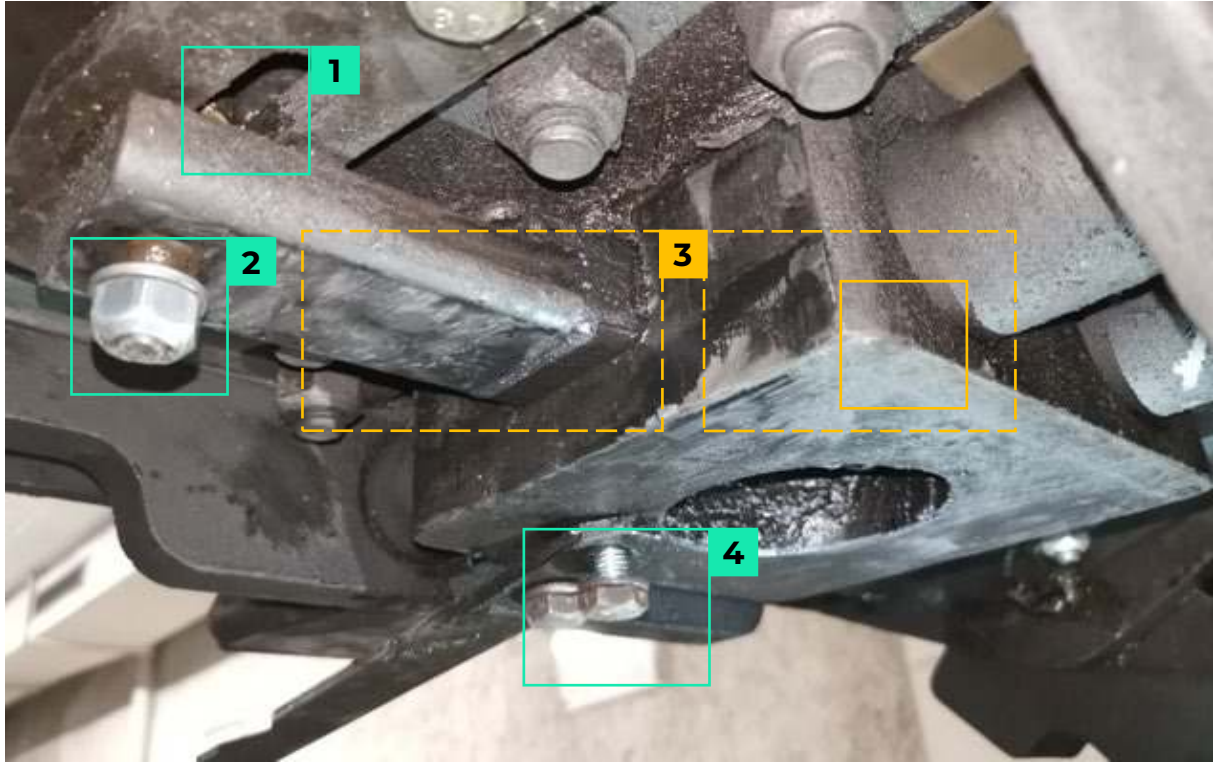

1. Short wrench to counter hold otherwise the thread will idle

2. Remove Nut!

3. Degrease, roughen and clean surfaces

Mounting position magnet



4. Remove screws!

Steps:

1. Unlock the hitch
2. Remove the nut from the pin and the two screws holding the narrow metal plate.



- Attention, counter-nut! You need a second key with a short design to block the threaded rod!
3. Clean the adhesive surfaces where the housing plate and the magnet are glued.

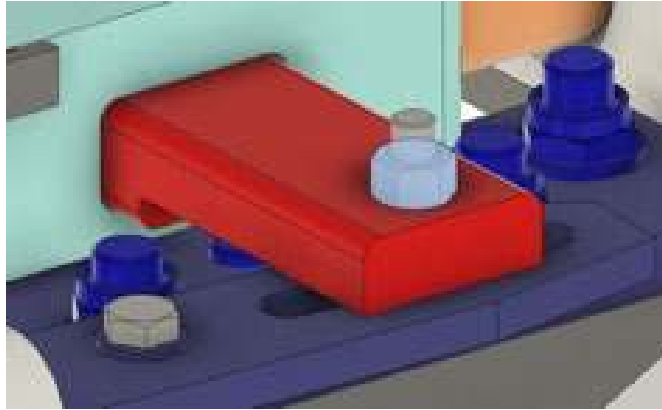

4.3 Fix QR Code Sticker with integrated NFC Tag on Hitch

Take the QR Code Sticker which is supplied inside the Kingpin Kit Package and attach it on the hitch as seen below.

Make sure to degrease, roughen and clean the surface before fixing the sticker on the hitch!

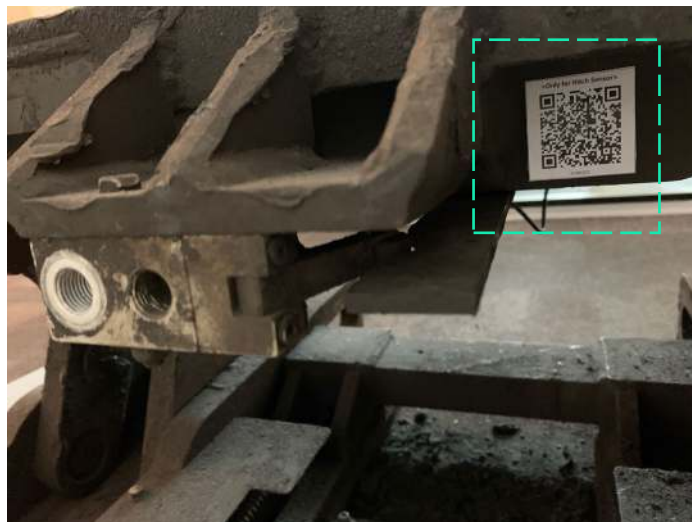



4.4 Activation of the sensor

The sensor is activated by holding a metal part to the Kingpin sensor for **at least 15s and then removing it again.**

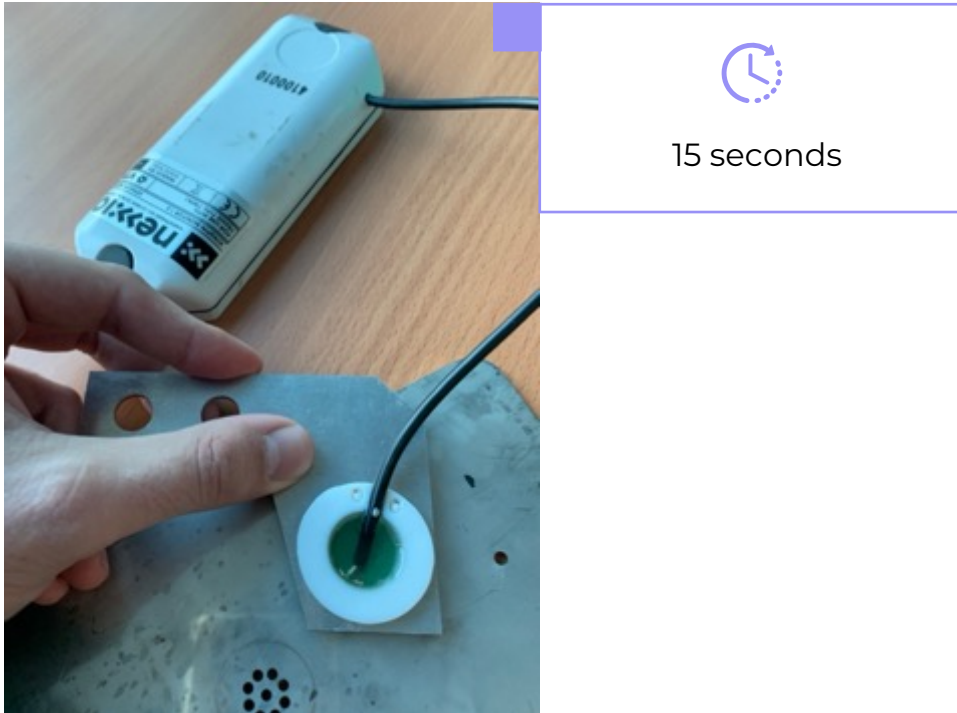

After 15s without metal nearby, the display shows the actual sensor status for 5 seconds when tapping the button after a short double light of the two left LEDs.



4.5 Adhesive sensor housing to the pin (Drawing views are shown upside down)

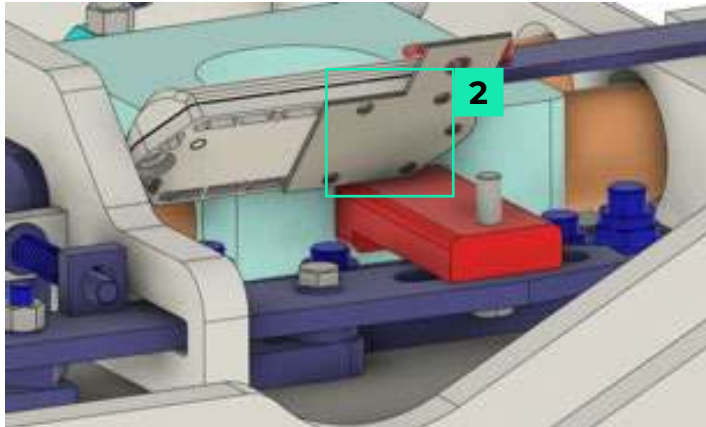

2. Apply 2 components Adhesive in crawler shape abundant on metal underside, which superimposes with the cone and carefully press the housing on the cone.

4.6 Screw the sensor housing to the pin



Screw the nut (counter wrench not visible in the picture above, this prevents the thread from turning)

Correct the alignment of the housing before the last tightening of the screw so that it is parallel to the middle block (see photo "View after mounting")



The drawing below shows the mounted sensor housing and its orientation:

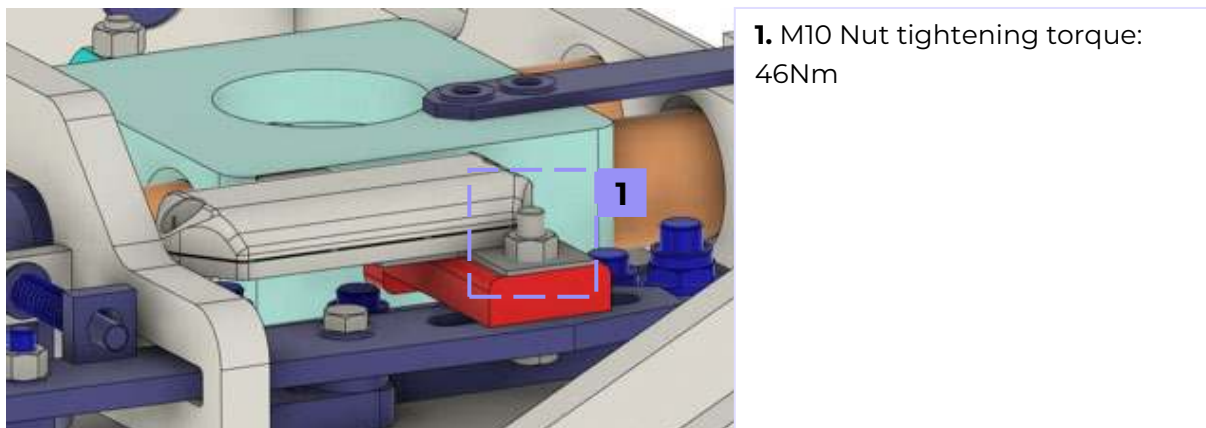

Now continue working quickly, because the 2K adhesive has a processing time of about 4-7 minutes after which the mixing nozzle is unusable.

Squeeze some glue out of the cartridge every 2-3 minutes so that the mixing nozzle does not clog!



4.7 Mounting of the magnet

Unlock the support trestle!

Place the magnetic bracket on as shown below and lock the support bracket!

Important:

Use the adhesive cartridge again to fix the magnet and bracket with a little glue.

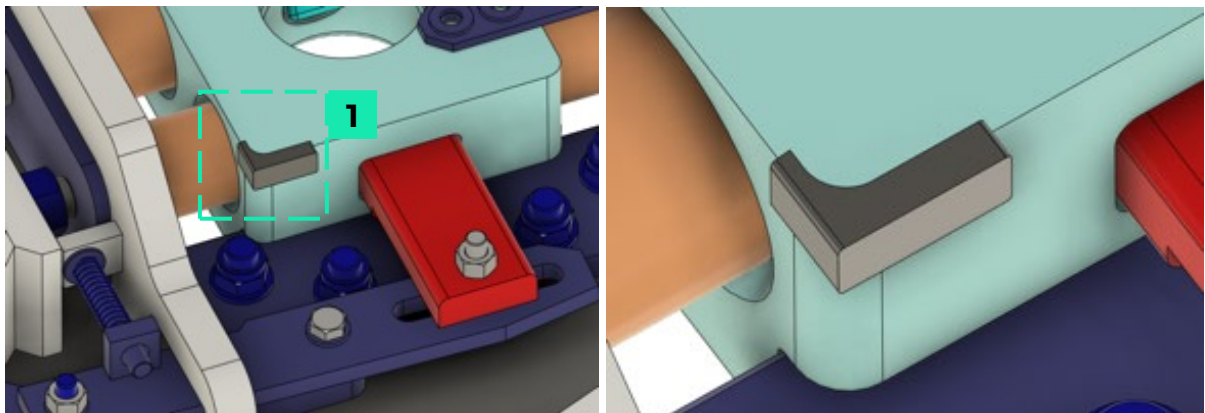

1. The magnetic holder must be brought to stop in the corner on both sides with the jugs

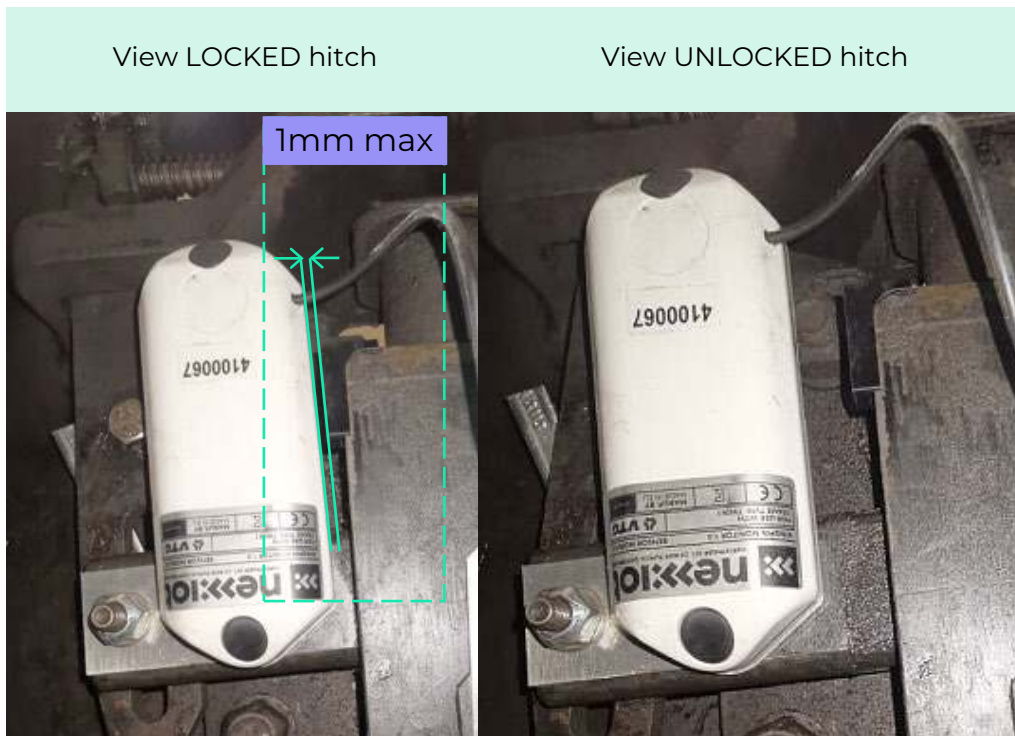

If the distance in the locked state is significantly greater than 1mm (e.B. 2mm and more), then please immediately loosen the nut of the metal plate slightly and correct the position of the housing accordingly.

Use the probe gauge from the toolbox to verify the distance!



4.8 Checking the locking sensor

An unlocking action of a few millimeters back on the pin should result in a transition of the right two LEDs from BLUE (penultimate LED) to RED (last LED from left to right) on the display within a few seconds.



4.9 Mount the external Kingpin sensor in the funnel

The external Kingpin sensor is a metal detector and detects the insertion of the kingpin from a distance of less than 6mm.

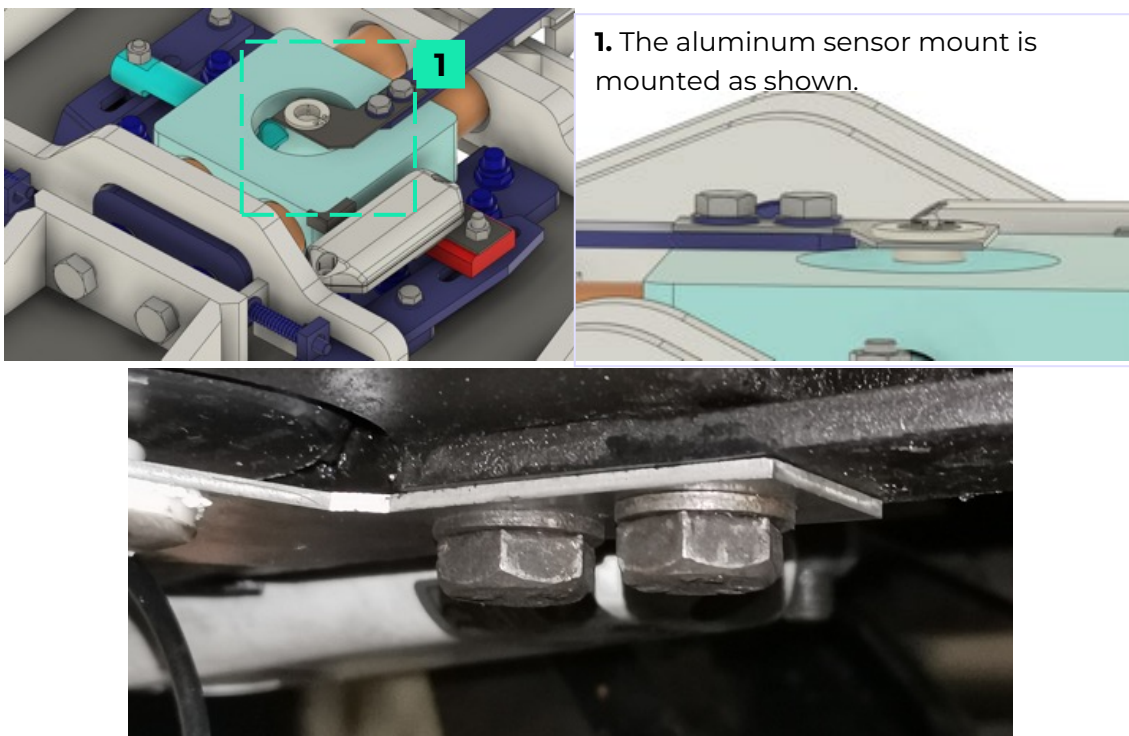



4.10 Checking the distance from the Kingpin sensor to the funnel

Please check the distance as shown in the picture below with the Kingpin Adapter (hitch unlocked).

Important: The distance from the sensor housing surface to the Kingpin Adapter, if completely inserted in the funnel, must be 2-3mm!

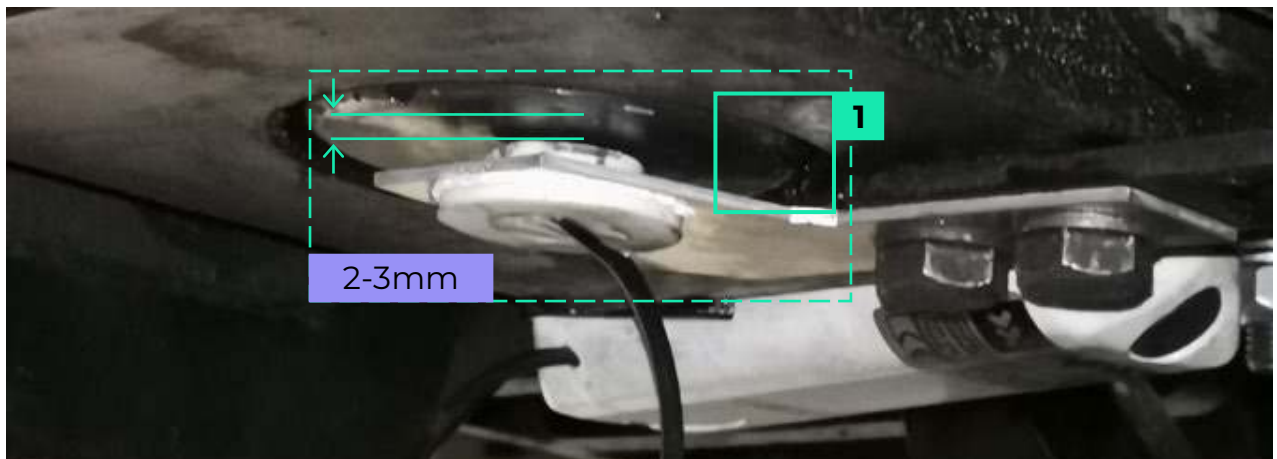

1. Kingpin adapter in the funnel

Attention:

If the distance to the Kingpin Adapter is less than 1mm or even lies directly on top, please use the washers enclosed in the kit to bring the distance of the holder to the ideal dimensions of 2-3mm! The washers are to be underlaid with the two screws that fasten the bracket.



5 Functional test of the complete system

Check the function of the sensors by inserting and removing the Kingpin Adapter into the hitch as well as by locking and unlocking the locking bar.

1. **Insert the Kingpin Adapter into the support bracket** and check whether the LEDs light up blue-blue when locked:

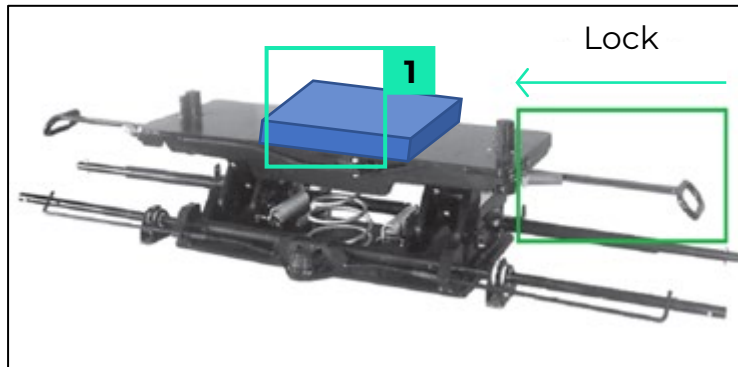

1. Kingpin Adapter Inside



2. **Now unlock** the support bracket and check whether a blue - red combination lights up:

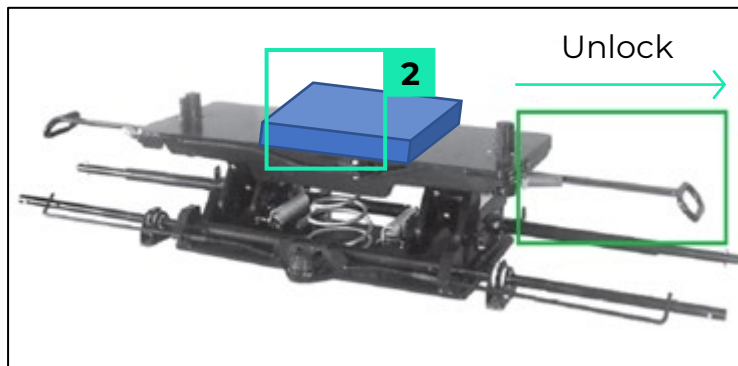

2. Kingpin Adapter Inside





3. **Now remove the Kingpin Adapter** and check whether the LEDs light up red-blue when locked:

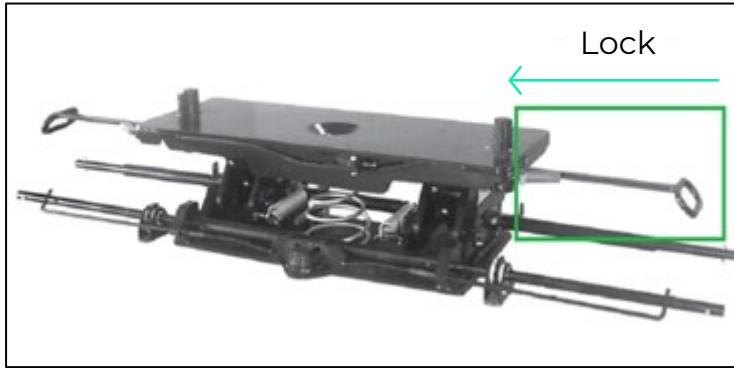

4. **Now unlock the support bracket** and check whether a red-red combination lights up:

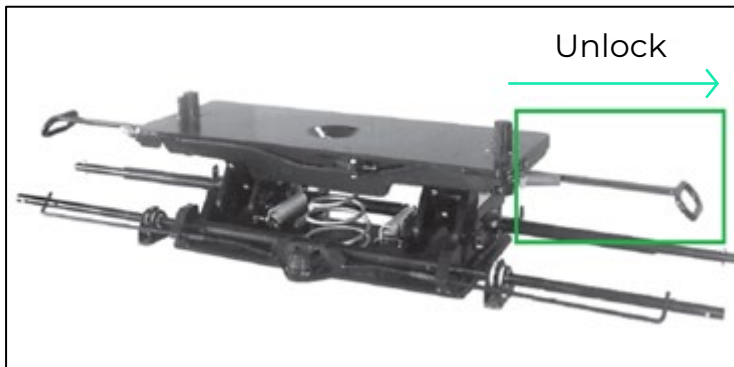



6 Display Installation & Pairing of Kingpin Kit with Globehopper

The two displays of the sensor kit are already paired in advance with the respective sensor of the kit (receiving only signals from this sensor).

Please follow the **assembly instructions of the displays** for mounting on the wagon.

Please use the **pairing app** to connect the sensors and the displays to the respective telematics main device (Globehopper/Connector) of the wagon.

